



BOARD OF CONTRACT AND SUPPLY
CITY OF PROVIDENCE, RHODE ISLAND

REQUEST FOR PROPOSALS

Item Description: INLET STONES 19-20

Date to be opened: MAY 28, 2019

Issuing Department: PUBLIC WORKS

QUESTIONS

- Please direct questions relative to the bidding process, how to fill out forms, and how to submit a bid (Pages 1-8) to Purchasing Agent Patti Jordan.
 - Phone: (401) 680-5264
 - Email: pjordan@providenceri.gov
 - Please use the subject line “**RFP Question**”
- Please direct questions relative to the Minority and Women’s Business Enterprise Program and the corresponding forms (Pages 9-13) to the MBE/WBE Outreach Director for the City of Providence, Grace Diaz
 - Phone: (401) 680-5766
 - Email: gdiaz@providenceri.gov
 - Please use subject line “**MBE WBE Forms**”
- Please direct questions relative to the specifications outlined (beginning on page 14) to the issuing department’s subject matter expert:
 - **David Mambro**
 - Dmambro@providenceri.gov

Pre-bid Conference

THERE IS NO PRE-BID CONFERENCE.



**BOARD OF CONTRACT AND SUPPLY
CITY OF PROVIDENCE, RHODE ISLAND**

INSTRUCTIONS FOR SUBMISSION

Bids may be submitted up to **2:15 P.M.** on the above meeting date at the **Department of the City Clerk, Room 311, City Hall, 25 Dorrance Street, Providence.** At 2:15 P.M. all bids will be publicly opened and read at the Board of Contract Meeting in the City Council Chambers, on the 3rd floor of City Hall.

- Bidders must submit **2 copies** of their bid in sealed envelopes or packages labeled with the captioned **Item Description** and the **City Department to which the RFP and bid are related.** (On page 1)
- Communications to the Board of Contract and Supply that are not competitive sealed bids (i.e. product information/samples) should have “**NOT A BID**” written on the envelope or wrapper.
- Only use form versions and templates included in this RFP. If you have an old version of a form do not recycle it for use in this bid.
- The bid envelope and information relative to the bid must be addressed to:

**Board of Contract and Supply
Department of the City Clerk – City Hall, Room 311
25 Dorrance Street
Providence, RI 02903**

****PLEASE NOTE:** This bid may include details regarding information that you will need to provide (such as proof of licenses) to the issuing department before the formalization of an award.

This information is NOT requested to be provided in your initial bid by design.

All bids submitted to the City Clerk become public record. Failure to follow instructions could result in information considered private being posted to the city’s Open Meetings Portal and made available as a public record. The City has made a conscious effort to avoid the posting of sensitive information on the City’s Open Meetings Portal, by requesting that such sensitive information be submitted to the issuing department only at their request.



**BOARD OF CONTRACT AND SUPPLY
CITY OF PROVIDENCE, RHODE ISLAND**

BID PACKAGE CHECKLIST

Digital forms are available in the City of Providence Purchasing Department Office or online at <http://www.providenceri.gov/purchasing/how-to-submit-a-bid/>

The bid package **MUST** include the following, in this order:

- Bid Form 1: Bidder's Blank as the cover page/ 1st page (*see page 6 of this document*)
- Bid Form 2: Certification of Bidder as 2nd page (*see page 7 of this document*)
- Certificate Regarding Public Records (*see page 8 of this document*)
- Forms from the Minority and Women Business Enterprise Program: Based on Bidder Category. *See forms and instructions enclosed (pages 9-13) or on: <https://www.providenceri.gov/purchasing/minority-women-owned-business-mbewbe-procurement-program/>*

***Please note: MBE/WBE forms must be completed for EVERY bid submitted and must be inclusive of ALL required signatures. Forms without all required signatures will be considered incomplete.**

- Bidder's Proposal/Packet: Formal response to the specifications outlined in this RFP, including pricing information and details related to the good(s) or service(s) being provided. Please be mindful of formatting responses as requested to ensure clarity.
- Financial Assurance, *if requested* (as indicated on page 5 of this document under "Bid Terms")

All of the above listed documents are REQUIRED. (With the exception of financial assurances, which are only required if specified on page 5.)

*****Failure to meet specified deadlines, follow specific submission instructions, or enclose all required documents with all applicable signatures will result in disqualification, or in an inability to appropriately evaluate bids.**



**BOARD OF CONTRACT AND SUPPLY
CITY OF PROVIDENCE, RHODE ISLAND**

NOTICE TO VENDORS

1. The Board of Contract and Supply will make the award to the lowest qualified and responsible bidder.
2. In determining the lowest responsible bidder, cash discounts based on preferable payment terms will not be considered.
3. Where prices are the same, the Board of Contract and Supply reserves the right to award to one bidder, or to split the award.
4. No proposal will be accepted if the bid is made in collusion with any other bidder.
5. Bids may be submitted on an "equal in quality" basis. The City reserves the right to decide equality. Bidders must indicate brand or the make being offered and submit detailed specifications if other than brand requested.
6. A bidder who is an out-of-state corporation shall qualify or register to transact business in this State, in accordance with the Rhode Island Business Corporation Act, RIGL Sec. 7-1.2-1401, et seq.
7. The Board of Contract and Supply reserves the right to reject any and all bids.
8. Competing bids may be viewed in person at the Department of the City Clerk, City Hall, Providence, immediately upon the conclusion of the formal Board of Contract and Supply meeting during which the bids were unsealed/opened. Bids may also be accessed electronically on the internet via the City's [Open Meetings Portal](#).
9. As the City of Providence is exempt from the payment of Federal Excise Taxes and Rhode Island Sales Tax, prices quoted are not to include these taxes.
10. In case of error in the extension of prices quoted, the unit price will govern.
11. The contractor will **NOT** be permitted to: a) assign or underlet the contract, or b) assign either legally or equitably any monies or any claim thereto without the previous written consent of the City Purchasing Director.
12. Delivery dates must be shown in the bid. If no delivery date is specified, it will be assumed that an immediate delivery from stock will be made.
13. A certificate of insurance will normally be required of a successful vendor.
14. For many contracts involving construction, alteration and/or repair work, State law provisions concerning payment of prevailing wage rates apply ([RIGL Sec. 37-13-1 et seq.](#))
15. No goods should be delivered or work started without a Purchase Order.
16. **Submit 2 copies of the bid to the City Clerk, unless the specification section of this document indicates otherwise.**
17. Bidder must certify that it does not unlawfully discriminate on the basis of race, color, national origin, gender, gender identity or expression, sexual orientation and/or religion in its business and hiring practices and that all of its employees are lawfully employed under all applicable federal, state and local laws, rules and regulations. (See Bid Form 2.)



**BOARD OF CONTRACT AND SUPPLY
CITY OF PROVIDENCE, RHODE ISLAND**

BID TERMS

1. Financial assurances may be required in order to be a successful bidder for Commodity or Construction and Service contracts. If either of the first two checkboxes below is checked, the specified assurance must accompany a bid, or the bid will not be considered by the Board of Contract and Supply. The third checkbox indicates the lowest responsible bidder will be contacted and required to post a bond to be awarded the contract.
 - a) A certified check for \$_____ must be deposited with the City Clerk as a guarantee that the Contract will be signed and delivered by the bidder.
 - b) A bid bond in the amount of _____ per centum (%) of the proposed total price, must be deposited with the City Clerk as a guarantee that the contract will be signed and delivered by the bidder; and the amount of such bid bond shall be retained for the use of the City as liquidated damages in case of default.
 - c) A performance and payment bond with a satisfactory surety company will be posted by the bidder in a sum equal to one hundred per centum (100%) of the awarded contract.
 - d) No financial assurance is necessary for this item.
2. Awards will be made within **sixty (60) days of bid opening**. All bid prices will be considered firm, unless qualified otherwise. Requests for price increases will not be honored.
3. Failure to deliver within the time quoted or failure to meet specifications may result in default in accordance with the general specifications. It is agreed that deliveries and/or completion are subject to strikes, lockouts, accidents and Acts of God.

The following entry applies only for COMMODITY BID TERMS:

4. Payment for partial delivery will not be allowed except when provided for in blanket or term contracts.

The following entries apply only for CONSTRUCTION AND SERVICE BID TERMS:

5. Only one shipping charge will be applied in the event of partial deliveries for blanket or term contracts.
6. Prior to commencing performance under the contract, the successful bidder shall attest to compliance with the provisions of the Rhode Island Worker's Compensation Act, RIGL 28-29-1, et seq. If exempt from compliance, the successful bidder shall submit a sworn Affidavit by a corporate officer to that effect, which shall accompany the signed contract.
7. Prior to commencing performance under the contract, the successful bidder shall, submit a certificate of insurance, in a form and in an amount satisfactory to the City.



**BOARD OF CONTRACT AND SUPPLY
CITY OF PROVIDENCE, RHODE ISLAND**

BID FORM 1: Bidders Blank

1. Bids must meet the attached specifications. Any exceptions or modifications must be noted and fully explained.
2. Bidder's responses must be in ink or typewritten, and all blanks on the bid form should be completed.
3. The price or prices proposed should be stated both in **WRITING** and in **FIGURES**, and any proposal not so stated may be rejected. **Contracts exceeding twelve months must specify annual costs for each year.**
4. Bids **SHOULD BE TOTALED** so that the final cost is clearly stated (unless submitting a unit price bid), however **each item should be priced individually**. Do not group items. Awards may be made on the basis of *total* bid or by *individual items*.
5. All bids **MUST BE SIGNED IN INK.**

Name of Bidder (Firm or Individual): _____

Contact Name: _____

Business Address: _____

Business Phone #: _____

Contact Email Address: _____

Agrees to bid on (Items(s) to be bid): _____

If the bidder's company is based in a state *other than Rhode Island*, list name and contact information for a local agent for service of process that *is located within Rhode Island* _____

Please visit <http://www.naics.com/search/> and identify the NAICS Code(s) for items being bid on. Enter the NAICS code(s) here or in parentheses next to each item listed immediately above: _____

Delivery Date (if applicable): _____

Name of Surety Company (if applicable): _____

Total Amount in Writing*: _____

Total Amount in Figures*: _____

**** If you are submitting a unit price bid, please insert "Unit Price Bid"***

Use additional pages if necessary for additional bidding details.

Signature of Representation

Title



BOARD OF CONTRACT AND SUPPLY
CITY OF PROVIDENCE, RHODE ISLAND

BID FORM 2: Certification of Bidder
(Non-Discrimination/Hiring)

Upon behalf of _____ (Firm or Individual Bidding),

I, _____ (Name of Person Making Certification),

being its _____ (Title or "Self"), hereby certify that:

1. Bidder does not unlawfully discriminate on the basis of race, color, national origin, gender, sexual orientation and/or religion in its business and hiring practices.
2. All of Bidder's employees have been hired in compliance with all applicable federal, state and local laws, rules and regulations.

I affirm by signing below that I am duly authorized on behalf of Bidder, on
this _____ day of _____ 20_____.

Signature of Representation

Printed Name



**BOARD OF CONTRACT AND SUPPLY
CITY OF PROVIDENCE, RHODE ISLAND**

Certificate Regarding Public Records

Upon behalf of _____ (Firm or Individual Bidding),

I, _____ (Name of Person Making Certification),

being its _____ (Title or "Self"), hereby certify an

understanding that:

1. All bids submitted in response to Requests for Proposals (RFP's) and Requests for Qualification (RFQ's), documents contained within, and the details outlined on those documents become public record upon receipt by the City Clerk's office and opening at the corresponding Board of Contract and Supply (BOCS) meeting.
2. The Purchasing Department and the issuing department for this RFP/RFQ have made a conscious effort to request that sensitive/personal information be submitted directly to the issuing department and only at request if verification of specific details is critical the evaluation of a vendor's bid.
3. The requested supplemental information may be crucial to evaluating bids. Failure to provide such details may result in disqualification, or an inability to appropriately evaluate bids.
4. If sensitive information that has not been requested is enclosed or if a bidder opts to enclose the defined supplemental information prior to the issuing department's request in the bidding packet submitted to the City Clerk, the City of Providence has no obligation to redact those details and bears no liability associated with the information becoming public record.
5. The City of Providence observes a public and transparent bidding process. Information required in the bidding packet may not be submitted directly to the issuing department at the discretion of the bidder in order to protect other information, such as pricing terms, from becoming public. Bidders who make such an attempt will be disqualified.

I affirm by signing below that I am duly authorized on behalf of Bidder, on

this _____ day of _____ 20_____.

Signature of Representation

Printed Name



**BOARD OF CONTRACT AND SUPPLY
CITY OF PROVIDENCE, RHODE ISLAND**

WBE/MBE Form Instructions

The City of Providence actively seeks Minority and Women business enterprises to participate in bids to meet the City's procurement needs. Pursuant to the City of Providence Code of Ordinances, Chapter 21, Article II, Sec. 21-52 (Minority and Women's Business Enterprise) and Rhode Island General Laws (as amended), Chapter 31-14, et seq. (Minority Business Enterprise), Minority Business Enterprise (MBE) and Women's Business Enterprise (WBE) participation goals apply to contracts.

The goal for Minority Business Enterprise (MBE) participation is **10%** of the total bid value.

The goal for Women's Business Enterprise (WBE) participation is **10%** of the total bid value.

The goal for combined MBE/WBE participation is **20%** of the total bid value.

Only businesses certified with the State of Rhode Island as minority and/or women business enterprises are counted towards the City's goals. Eligible minority or women-owned businesses are encouraged to seek certification from the State of Rhode Island Minority Business Enterprise Compliance Office at: <http://odeo.ri.gov/offices/mbeco/>

Note: MBE certification with the State of Rhode Island on the basis of Portuguese heritage is not currently recognized by the City of Providence's MBE program.

Bid Requirements:

All Bidders: All bidders must complete and submit the **MBE/WBE Participation Affidavit** indicating whether or not they are a state-certified MBE/WBE and acknowledging the City's participation goals. Submission of this form is required with **every bid**. Your bid will not be accepted without an affidavit.

Bidders who will be subcontracting: Bidders who will be subcontracting must submit the **Subcontractor Disclosure Form** as part of their bid submission. All subcontractors, regardless of MBE/WBE status, must be listed on this form. Business NAICS codes can be found at <https://www.naics.com/search/>. Awarded bidders are required to submit **Subcontractor Utilization and Payment Reports** with each invoice.

Waiver Requests:

If the percentage of the total amount of the bid being awarded to MBE or WBE vendors is less than 20% (Box F on the Subcontractor Disclosure Form) and the prime contractor is not a Rhode Island State-certified MBE or WBE, the Bidder must complete the **MBE/WBE Waiver Request Form** for review. Waivers will be considered on a case by case basis.

No waiver will be granted unless the waiver request includes documentation that demonstrates that the Bidder has made good faith efforts to achieve the City's stated participation goals. Waivers must be reviewed and signed by the City of Providence's MBE/WBE Outreach Director, Grace Diaz, or her designee. Department Directors cannot recommend a bidder for award if this form is applicable and absent. If the bid does not meet the participation goals of the City of Providence and a waiver is not filed with the signature of the MBE/WBE Outreach Director or her designee, the bid will not be accepted.

Verifying MBE/WBE Certification

It is the responsibility of the bidder to confirm that every MBE/WBE named in a proposal and included in a contract is certified by the Rhode Island Minority Business Enterprise Compliance office. The current MBE/WBE directory is available at the State of RI MBE Office, One Capitol Hill, 2nd Floor, Providence, RI, or online at <http://odeo.ri.gov/offices/mbeco/mbe-wbe.php>. You can also call (401) 574-8670 to verify certification, expiration dates, and services that the MBE/WBE is certified to provide. Note: MBE certification with the State of Rhode Island on the basis of Portuguese heritage is not currently recognized by the City of Providence's MBE program.

Form Instructions:

Access all bid forms from <http://www.providenceri.gov/oeo/> or <http://www.providenceri.gov/purchasing/minority-women-owned-business-mbewbe-procurement-program/>. **Download** the forms as blank PDFs. Once saved on your computer, fill them out using the Adobe program. The fillable PDFs must be completed in Adobe in order to be saved property. Google Chrome and similar



**BOARD OF CONTRACT AND SUPPLY
CITY OF PROVIDENCE, RHODE ISLAND**

platforms do not allow for the forms to be saved as filled PDFs. Therefore, please download the blank forms to your computer, then fill them out and save.

Assistance with Form Requirements

Examples of completed forms can be found on the City of Providence website at <http://www.providenceri.gov/oeo/> or <http://www.providenceri.gov/purchasing/minority-women-owned-business-mbewbe-procurement-program/>.

Contract Requirements:

Prime contractors engaging subcontractors must submit the *Subcontractor Utilization and Payment Report* to the City Department's Fiscal Agent with every invoice and with request for final payment. This form is not submitted as a part of the initial bid package.

For contracts with duration of less than 3 months, this form must be submitted along with the contractor's request for final payment. The form must include all subcontractors utilized on the contract, both MBE/WBE and non- MBE/WBE, the total amount paid to each subcontractor for the given period and to date. During the term of the contract, any unjustified failure to comply with the MBE/WBE participation requirements is a material breach of contract.

Questions?

For more information or for assistance with MBE/WBE Forms, contact the City of Providence MBE/WBE Outreach Director, Grace Diaz, at mbe-wbe@providenceri.com or (401) 680-5766.



**BOARD OF CONTRACT AND SUPPLY
CITY OF PROVIDENCE, RHODE ISLAND**

MBE/WBE PARTICIPATION AFFIDAVIT

Item Discussion (as seen on RFP):

Prime Bidder: _____

Prime Bidder (Company) Phone Number: _____

Prime Bidder (Company) Zip Code: _____

Which one of the following describes your business' status in terms of Minority and/or Woman-Owned Business Enterprise certification with the State of Rhode Island? MBE WBE Neither MBE nor WBE

By initialing the following sections and signing the bottom of this document in my capacity as the contractor or an authorized representative of contractor, I make this Affidavit:

It is the policy of the City of Providence that minority business enterprises (MBEs) and women business enterprises (WBEs) should have the maximum opportunity to participate in procurements and projects as prime contractors and vendors. Pursuant to Sec. 21-52 of the Providence Code of Ordinances and Chapter 31-14 *et seq.* of the Rhode Island General Laws (as amended), MBE and WBE participation goals apply to contracts.

The goal for Minority Business Enterprise (MBE) participation is 10% of the total bid value.
The goal for Women's Business Enterprise (WBE) participation is 10% of the total bid value.
The goal for combined MBE/WBE participation is 20% of the total bid value.

I acknowledge the City of Providence's goals of supporting MBE/WBE certified businesses. Initial _____

If awarded the contract, I understand that my company must submit to the Minority and Women's Business Coordinator at the City of Providence (MBE/WBE Office), copies of all executed agreements with the subcontractor(s) being utilized to achieve the participation goals and other requirements of the RI General Laws. **I understand that these documents must be submitted prior to the issuance of a notice to proceed.** Initial _____

I understand that, if awarded the contract, my firm must submit to the MBE/WBE Office canceled checks and reports required by the MBE/WBE Office on a quarterly basis verifying payments to the subcontractors(s) utilized on the contract. Initial _____

If I am awarded this contract and find that I am unable to utilize the subcontractor(s) identified in my Statement of Intent, I understand that I must substitute another certified MBE and WBE firm(s) to meet the participation goals. **I understand that I may not make a substitution until I have obtained the written approval of the MBE/WBE Office.**
Initial _____

If awarded this contract, I understand that authorized representatives of the City of Providence may examine the books, records and files of my firm from time to time, to the extent that such material is relevant to a determination of whether my firm is complying with the City's MBE/WBE participation requirements.
Initial _____

I do solemnly declare and affirm under the penalty of perjury that the contents of the foregoing Affidavit are true and correct to the best of my knowledge, information and belief.

Signature of Bidder

Printed Name

Company Name

Date



**BOARD OF CONTRACT AND SUPPLY
CITY OF PROVIDENCE, RHODE ISLAND**

SUBCONTRACTOR DISCLOSURE FORM

Fill out this form only if you WILL SUBCONTRACT with other parties. If you will not subcontract any portion of the proposed bid, do not fill out this form.

Prime Bidder: _____ Primary NAICS _____

Code: _____

Item Description (as seen on RFP): _____

Please list all Subcontractors below. Include the total dollar value that you propose to share with each subcontractor and the dollar amount to be subcontracted. Please check off MBE and WBE where applicable. The directory of all state-certified MBE/WBE firms is located at www.mbe.ri.gov. Business NAICS codes can be found at <https://www.naics.com/search/>

Proposed Subcontractor	MBE	WBE	Primary NAICS Code	Date of Mobilization	\$ Value of Subcontract
					\$
					\$
					\$
					\$
					\$
					\$
A. MBE SUBCONTRACTED AMOUNT:					\$
B. WBE SUBCONTRACTED AMOUNT:					\$
C. NON MBE WBE SUBCONTRACTED AMOUNT:					\$
D. DOLLAR AMOUNT OF WORK DONE BY THE PRIME CONTRACTOR:					\$
E. TOTAL AMOUNT OF BID (SUM OF A, B, C, & D):					\$
F. PERCENTAGE OF BID SUBCONTRACTED TO MBEs AND WBEs. (Divide the sum of A and B by E and multiply result by 100).					%

Please read and initial the following statement acknowledging you understand. If the percentage of the total amount of the bid being awarded to MBE or WBE vendors is less than 20% (Box F) and the prime contractor is NOT a Rhode Island State-certified MBE or WBE, you must fill out the MBE/WBE WAIVER REQUEST FORM for consideration by City of Providence MBE/WBE Outreach Director. Initial _____

Signature of Bidder

Printed Name



**BOARD OF CONTRACT AND SUPPLY
CITY OF PROVIDENCE, RHODE ISLAND**

MBE/WBE Waiver Request Form

**Fill out this form only if you are subcontracting and did not meet the 20% MBE/WBE participation goal.
State-certified MBE or WBE Prime Bidders are NOT REQUIRED to fill out this form.**

Submit this form to the City of Providence MBE/WBE Outreach Director, Grace Diaz, at mbe-wbe@providenceri.gov, for review **prior to bid submission**. This waiver applies only to the current bid which you are submitting to the City of Providence and does not apply to other bids your company may submit in the future.

Prime Bidder: _____

Company Trade: _____

Item Discussion (as seen on RFP):

To receive a waiver, you must list the certified MBE and/or WBE companies you contacted, the name of the primary individual with whom you interacted, and the reason the MBE/WBE company could not participate on this project.

MBE/WBE Company Name	Individual's Name	Company Trade	Why did you choose not to work with this company?

I acknowledge the City of Providence's goal of a combined MBE/WBE participation is 20% of the total bid value. I am requesting a waiver of _____ % MBE/WBE (20% minus the value of **Box F** on the Subcontractor Disclosure Form). If an opportunity is identified to subcontract any task associated with the fulfillment of this contract, a good faith effort will be made to select MBE/WBE certified businesses as partners.

Signature of Prime Contractor

Printed Name

Date Signed

Signature of City of Providence
MBE/WBE Outreach Director

Printed Name of City of Providence
MBE/WBE Outreach Director

Date Signed

Antonio J. Morabito
Director



Jorge O. Elorza
Mayor

DEPARTMENT OF PUBLIC WORKS
"Building Pride in Providence"

BIDDER'S BLANK - PAGE 1

DATE: _____

Honorable Jorge O. Elorza, Chairman
Board of Contract and Supply
City Hall
Providence, RI 02903

_____ agrees to bid on:
(Name of Company)

REQUEST FOR BID PROPOSAL FOR IRON CASTINGS FY18/19 (Blanket Order)
(Items to be bid)

(Date of Award)

(Total Amount in Writing)

(Total Amount in Figures)

ITEM NO.	QUANTITY	ITEM	UNIT BID PRICE	TOTAL BID PRICE
1.	30	Granite Inlet Stones 24" Opening-Standard 7.36P, or equal	\$ _____	\$ _____
2.	5	Granite Apron Stones 24" Opening-Standard 7.37P or equal	\$ _____	\$ _____

Federal ID# or Social Security # _____

Signature: _____

Title of Person Signing: _____

Firm Name: _____

Address: _____

Phone #: _____

Delivery Date: _____

Name of Surety Company: _____

Percentage of minority participation in this contract is _____ %.

BACK SURFACE SHALL HAVE NO PROJECTIONS FOR A DISTANCE OF 3" DOWN FROM THE TOP UNLESS OTHERWISE SAWN

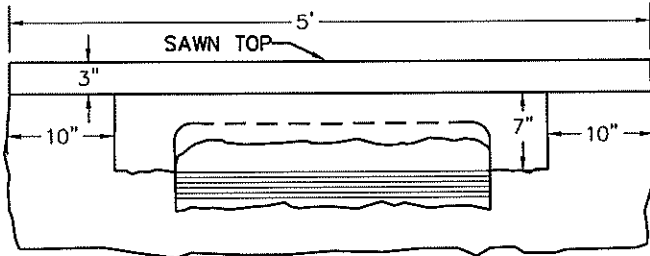

REAR VIEW
N.T.S.

QUARRY FACED WITH NO PORTIONS MORE THAN 1" ABOVE OR MORE THAN 1" BELOW A GENERAL PLANE, UNLESS OTHERWISE SAWN

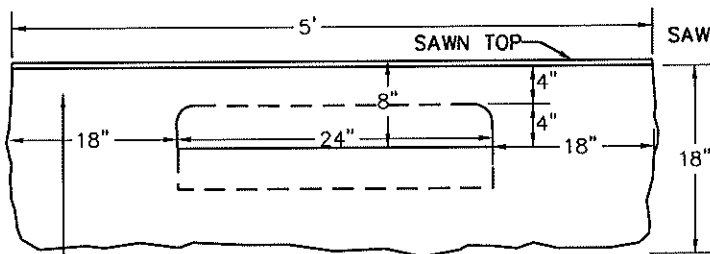

FRONT VIEW
N.T.S.

END OF ALL STONES SHALL BE SQUARE AND SO FINISHED THAT WHEN STONES ARE SET NO SPACE MORE THAN 1/4" SHALL SHOW IN THE JOINT FOR THE FULL WIDTH OF THE TOP OR DOWN THE FACE FOR 9", UNLESS OTHERWISE SAWN

LOWER HALF OF ENDS MAY BE QUARRY FACED WITH NO PROJECTIONS BEYOND DEPRESSED PORTION AND NO DEPRESSION MORE THAN 1" DEEP

FRONT FACE SHALL BE AT RIGHT ANGLES TO THE PLANE OF THE TOP AND SHALL BE SMOOTH QUARRY SPLIT, UNLESS OTHERWISE SAWN

FRONT FACE SHALL HAVE NO PROJECTION GREATER THAN 3/4" OR DEPRESSION GREATER THAN 1/2" FOR A DISTANCE DOWN FROM THE TOP OF 9", UNLESS OTHERWISE SAWN

GRANITE INLET STONE - 24" OPENING
N.T.S.

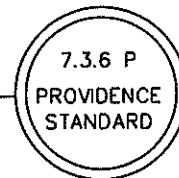

TOP SURFACE OF APRON OR REGULAR INLET STONE SHALL BE SAWN TO APPROXIMATELY TRUE PLANES TOP SURFACE SHALL HAVE NO PROJECTION OR DEPRESSION GRATER THAN 1/8".

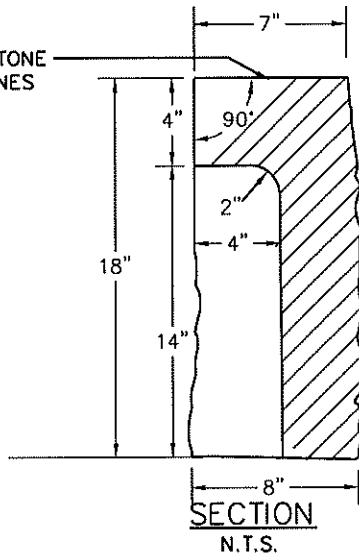

END OF ALL STONES SHALL BE SQUARE AND SO FINISHED THAT WHEN STONES ARE SET NO SPACE MORE THAN 1/4" SHALL SHOW IN THE JOINT FOR THE FULL WIDTH OF THE TOP OR DOWN THE FACE FOR 9"

QUARRY FACED WITH NO PORTIONS MORE THAN 1" ABOVE OR MORE THAN 1" BELOW A GENERAL PLANE, UNLESS OTHERWISE SAWN

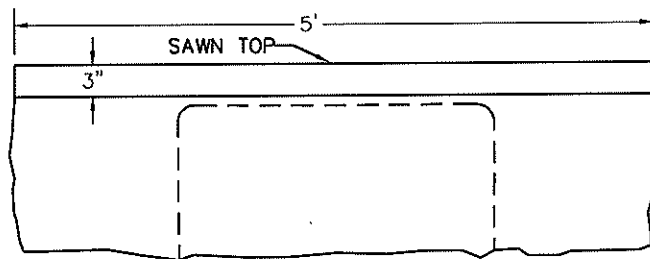

FRONT FACE SHALL BE AT RIGHT ANGLES TO THE PLANE OF THE TOP AND SHALL BE SMOOTH QUARRYSPLIT UNLESS OTHERWISE SAWN

REAR VIEW
N.T.S.

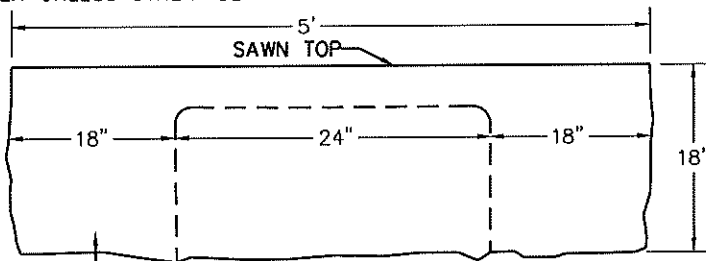

FRONT VIEW
N.T.S.



LOWER HALF OF ENDS MAY BE QUARRY FACED WITH NO PROJECTIONS BEYOND DEPRESSED PORTION AND NO DEPRESSION MORE THAN 1" DEEP

FRONT FACE SHALL HAVE NO PROJECTION GREATER THAN 3/4" OR DEPRESSION GREATER THAN 1/2" FOR A DISTANCE DOWN FROM THE TOP OF 9" UNLESS OTHERWISE SAWN

GRANITE APRON STONE - 24" OPENING

N.T.S.

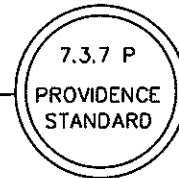



**BOARD OF CONTRACT AND SUPPLY
CITY OF PROVIDENCE, RHODE ISLAND**

SUPPLEMENTAL INFORMATION

If the issuing department for this RFP determines that your firm's bid is best suited to accommodate their need, you will be asked to provide proof of the following prior to formalizing an award.

An inability to provide the outlined items at the request of the department may lead to the disqualification of your bid.

*This information is **NOT** requested to be provided in your initial bid that you will submit to the City Clerk's office by the "date to be opened" noted on page 1. This list only serves as a list of items that your firm should be ready to provide on request.*

All bids submitted to the City Clerk become public record. Failure to follow instructions could result in information considered private being posted to the city's Open Meetings Portal and made available as a public record.

You must be able to provide:

- Business Tax ID will be requested after an award is approved by the Board of Contract and Supply.