



BOARD OF CONTRACT AND SUPPLY
CITY OF PROVIDENCE, RHODE ISLAND

REQUEST FOR PROPOSALS

Item Description: INLET STONES 23-24

Procurement/MinuteTraq #: 40932

Date to be opened: 6/20/2023

Issuing Department: Department of Public Works

QUESTIONS

- Please direct questions related to the bidding process, how to fill out forms, and how to submit a bid (Pages 1-8) to the Purchasing Department.
 - Email: purchasing@providenceri.gov
 - Please use the subject line “**Solicitation Question**”
- Please direct questions relative to the Minority and Women’s Business Enterprise Program and the corresponding forms (Pages 9-13) to the MBE/WBE Outreach Director for the City of Providence, Grace Diaz
 - Email: gdiaz@providenceri.gov
 - Please use subject line “**MBE WBE Forms**”
- Please direct questions relative to the specifications outlined (beginning on page 14) to the issuing department’s subject matter expert:
 - Name: David Mambro
 - Title: Sewer Superintendent
 - Email Address: Dmambro@providenceri.gov

Pre-bid Conference

There is no pre-bid conference scheduled for this item.



**BOARD OF CONTRACT AND SUPPLY
CITY OF PROVIDENCE, RHODE ISLAND**

INSTRUCTIONS FOR SUBMISSION

Bids may be submitted up to **2:15 P.M.** on the above meeting date at the **Department of the City Clerk, Room 311, City Hall, 25 Dorrance Street, Providence.** At 2:15 P.M. all bids will be publicly opened and read at the Board of Contract Meeting in Conference Room 305, on the 3rd floor of City Hall.

- Bidders must submit **2 copies** of their bid in sealed envelopes or packages labeled with the captioned **Item Description** and the **City Department to which the solicitation and bid are related and must include the company name and address on the envelope as well.** (On page 1).
- If required by the Department, please keep the original bid bond and check in only one of the envelopes.
- Communications to the Board of Contract and Supply that are not competitive sealed bids (i.e. product information/samples) should have **"NOT A BID"** written on the envelope or wrapper.
- Only use form versions and templates included in this solicitation. If you have an old version of a form **do not recycle it for use in this bid.**
- The bid envelope and information relative to the bid must be addressed to:

**Board of Contract and Supply
Department of the City Clerk – City Hall, Room 311
25 Dorrance Street
Providence, RI 02903**

****PLEASE NOTE:** This bid may include details regarding information that you will need to provide (such as proof of licenses) to the issuing department before the formalization of an award.

*This information is **NOT** requested to be provided in your initial bid by design.*

All bids submitted to the City Clerk become public record. Failure to follow instructions could result in information considered private being posted to the city's Open Meetings Portal and made available as a public record. The City has made a conscious effort to avoid the posting of sensitive information on the City's Open Meetings Portal, by requesting that such sensitive information be submitted to the issuing department only at their request.



**BOARD OF CONTRACT AND SUPPLY
CITY OF PROVIDENCE, RHODE ISLAND**

BID PACKAGE CHECKLIST

Digital forms are available in the City of Providence Purchasing Department Office or online at <http://www.providenceri.gov/purchasing/how-to-submit-a-bid/>

The bid package **MUST** include the following, in this order:

- Bid Form 1: Bidder's Blank as the cover page/ 1st page (*see page 6 of this document*)
- Bid Form 2: Certification of Bidder as 2nd page (*see page 7 of this document*)
- Bid Form 3: Certificate Regarding Public Records (*see page 8 of this document*)
- Bid Form 4: Affidavit of City Vendor (*see pages 9 and 10 of this document*)
- Forms from the Minority and Women Business Enterprise Program: Based on Bidder Category. See *forms and instructions enclosed (pages 11-15) or on:*
<https://www.providenceri.gov/purchasing/minority-women-owned-business-mbewbe-procurement-program/>

***Please note: MBE/WBE forms must be completed for EVERY bid submitted and must be inclusive of ALL required signatures. Forms without all required signatures will be considered incomplete.**

- Bidder's Proposal/Packet: Formal response to the specifications outlined in this RFP, including pricing information and details related to the good(s) or service(s) being provided. Please be mindful of formatting responses as requested to ensure clarity.
- Financial Assurance, *if requested* (as indicated on page 5 of this document under "Bid Terms")

All of the above listed documents are REQUIRED. (With the exception of financial assurances, which are only required if specified on page 5.)

*****Failure to meet specified deadlines, follow specific submission instructions, or enclose all required documents with all applicable signatures will result in disqualification, or in an inability to appropriately evaluate bids.**



**BOARD OF CONTRACT AND SUPPLY
CITY OF PROVIDENCE, RHODE ISLAND**

NOTICE TO VENDORS

1. The Board of Contract and Supply will make the award to the lowest qualified and responsible bidder.
2. In determining the lowest responsible bidder, cash discounts based on preferable payment terms will not be considered.
3. Where prices are the same, the Board of Contract and Supply reserves the right to award to one bidder, or to split the award.
4. No proposal will be accepted if the bid is made in collusion with any other bidder.
5. Bids may be submitted on an "equal in quality" basis. The City reserves the right to decide equality. Bidders must indicate brand or the make being offered and submit detailed specifications if other than brand requested.
6. A bidder who is an out-of-state corporation shall qualify or register to transact business in this State, in accordance with the Rhode Island Business Corporation Act, RIGL Sec. 7-1.2-1401, et seq.
7. The Board of Contract and Supply reserves the right to reject any and all bids.
8. Competing bids may be viewed in person at the Department of the City Clerk, City Hall, Providence, immediately upon the conclusion of the formal Board of Contract and Supply meeting during which the bids were unsealed/opened. Bids may also be accessed electronically on the internet via the City's Open Meetings Portal.
9. As the City of Providence is exempt from the payment of Federal Excise Taxes and Rhode Island Sales Tax, prices quoted are not to include these taxes.
10. In case of error in the extension of prices quoted, the unit price will govern.
11. The contractor will **NOT** be permitted to: a) assign or underlet the contract, or b) assign either legally or equitably any monies or any claim thereto without the previous written consent of the City Purchasing Director.
12. Delivery dates must be shown in the bid. If no delivery date is specified, it will be assumed that an immediate delivery from stock will be made.
13. A certificate of insurance will normally be required of a successful vendor.
14. For many contracts involving construction, alteration and/or repair work, State law provisions concerning payment of prevailing wage rates apply (RIGL Sec. 37-13-1 et seq.)
15. No goods should be delivered, or work started without a Purchase Order.
16. **Submit 2 copies of the bid to the City Clerk, unless the specification section of this document indicates otherwise.**
17. Bidder must certify that it does not unlawfully discriminate on the basis of race, color, national origin, gender, gender identity or expression, sexual orientation and/or religion in its business and hiring practices and that all of its employees are lawfully employed under all applicable federal, state and local laws, rules and regulations. (See Bid Form 2.)



**BOARD OF CONTRACT AND SUPPLY
CITY OF PROVIDENCE, RHODE ISLAND**

BID TERMS

1. Financial assurances may be required in order to be a successful bidder for Commodity or Construction and Service contracts. If either of the first two checkboxes below is checked, the specified assurance must accompany a bid, or the bid will not be considered by the Board of Contract and Supply. The third checkbox indicates the lowest responsible bidder will be contacted and required to post a bond to be awarded the contract.
 - a) A certified check for \$_____ must be deposited with the City Clerk as a guarantee that the Contract will be signed and delivered by the bidder.
 - b) A bid bond in the amount of _____ per centum (%) of the proposed total price, must be deposited with the City Clerk as a guarantee that the contract will be signed and delivered by the bidder; and the amount of such bid bond shall be retained for the use of the City as liquidated damages in case of default. Any person signing a bid bond as an attorney-in-fact shall include with the bid bond an original, or a photocopy or facsimile of an original, power of attorney.
 - c) A performance and payment bond with a satisfactory surety company will be posted by the bidder in a sum equal to one hundred per centum (100%) of the awarded contract.
 - d) No financial assurance is necessary for this item.
2. Awards will be made within **sixty (60) days of bid opening**. All bid prices will be considered firm, unless qualified otherwise. Requests for price increases will not be honored.
3. Failure to deliver within the time quoted or failure to meet specifications may result in default in accordance with the general specifications. It is agreed that deliveries and/or completion are subject to strikes, lockouts, accidents, and Acts of God.

The following entry applies only for COMMODITY BID TERMS:

4. Payment for partial delivery will not be allowed except when provided for in blanket or term contracts.

The following entries apply only for CONSTRUCTION AND SERVICE BID TERMS:

5. Only one shipping charge will be applied in the event of partial deliveries for blanket or term contracts.
6. Prior to commencing performance under the contract, the successful bidder shall attest to compliance with the provisions of the Rhode Island Worker's Compensation Act, RIGL 28-29-1, et seq. If exempt from compliance, the successful bidder shall submit a sworn Affidavit by a corporate officer to that effect, which shall accompany the signed contract.
7. Prior to commencing performance under the contract, the successful bidder shall, submit a certificate of insurance, in a form and in an amount satisfactory to the City.

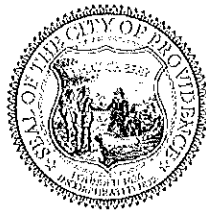

**BOARD OF CONTRACT AND SUPPLY
CITY OF PROVIDENCE, RHODE ISLAND**

BID FORM 1: Bidders Blank

1. Bids must meet the attached specifications. Any exceptions or modifications must be noted and fully explained.
2. Bidder's responses must be in ink or typewritten, and all blanks on the bid form should be completed.
3. The price or prices proposed should be stated both in **WRITING** and in **FIGURES**, and any proposal not so stated may be rejected. **Contracts exceeding twelve months must specify annual costs for each year.**
4. Bids **SHOULD BE TOTALED** so that the final cost is clearly stated (unless submitting a unit price bid), however **each item should be priced individually**. Do not group items. Awards may be made on the basis of *total* bid or by *individual items*.
5. All bids **MUST BE SIGNED IN INK.**

Name of Bidder (Firm or Individual): _____

Contact Name: _____

Business Address: _____

Business Phone #: _____

Contact Email Address: _____

Agrees to bid on (Write the "Item Description" here): _____

If the bidder's company is based in a state *other than Rhode Island*, list name and contact information for a local agent for service of process that *is located within Rhode Island*

Delivery Date (if applicable): _____

Name of Surety Company (if applicable): _____

Total Amount in Writing*: _____

Total Amount in Figures*: _____

**If you are submitting a unit price bid, please insert "Unit Price Bid"*

Use additional pages if necessary for additional bidding details.

Signature of Representation

Title



**BOARD OF CONTRACT AND SUPPLY
CITY OF PROVIDENCE, RHODE ISLAND**

**BID FORM 2: Certification of Bidder
(Non-Discrimination/Hiring)**

Upon behalf of _____ (Firm or Individual Bidding),

I, _____ (Name of Person Making Certification),

being its _____ (Title or "Self"), hereby certify that:

1. Bidder does not unlawfully discriminate on the basis of race, color, national origin, gender, sexual orientation and/or religion in its business and hiring practices.
2. All of Bidder's employees have been hired in compliance with all applicable federal, state and local laws, rules and regulations.

I affirm by signing below that I am duly authorized on behalf of Bidder, on

this _____ day of _____ 20_____.

Signature of Representation

Printed Name

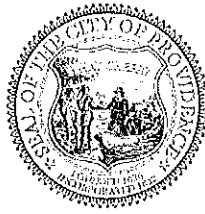

**BOARD OF CONTRACT AND SUPPLY
CITY OF PROVIDENCE, RHODE ISLAND**

BID FORM 3: Certificate Regarding Public Records

Upon behalf of _____ (Firm or Individual Bidding),

I, _____ (Name of Person Making Certification),

being its _____ (Title or "Self"), hereby certify an

understanding that:

1. All bids submitted in response to Requests for Proposals (RFP's) and Requests for Qualification (RFQ's), documents contained within, and the details outlined on those documents become public record upon receipt by the City Clerk's office and opening at the corresponding Board of Contract and Supply (BOCS) meeting.
2. The Purchasing Department and the issuing department for this RFP/RFQ have made a conscious effort to request that sensitive/personal information be submitted directly to the issuing department and only at request if verification of specific details is critical the evaluation of a vendor's bid.
3. The requested supplemental information may be crucial to evaluating bids. Failure to provide such details may result in disqualification, or an inability to appropriately evaluate bids.
4. If sensitive information that has not been requested is enclosed or if a bidder opts to enclose the defined supplemental information prior to the issuing department's request in the bidding packet submitted to the City Clerk, the City of Providence has no obligation to redact those details and bears no liability associated with the information becoming public record.
5. The City of Providence observes a public and transparent bidding process. Information required in the bidding packet may not be submitted directly to the issuing department at the discretion of the bidder in order to protect other information, such as pricing terms, from becoming public. Bidders who make such an attempt will be disqualified.

I affirm by signing below that I am duly authorized on behalf of Bidder, on

this _____ day of _____ 20_____.

Signature of Representation

Printed Name



**BOARD OF CONTRACT AND SUPPLY
CITY OF PROVIDENCE, RHODE ISLAND**

BID FORM 4: Affidavit of City Vendor

Per our Code of Ordinances Sec. 21.-28.1 (e), this form applies to a) the business, b) any political action committee whose name includes the name of the business, c) all persons holding ten (10) percent or greater equity interest or five thousand dollars (\$5,000.00) or greater cash value interest in the business at any time during the reporting period, d) all executive officers of the business entity, e) any spouse or dependent child of any individual identified in a) though d) above.

Executive officers who are not residents of the state of Rhode Island are exempted from this requirement.

Per R.I.G.L. § 36-14-2, "Business" means a sole proprietorship, partnership, firm, corporation, holding company, joint stock company, receivership, trust, or any other entity recognized in law through which business for profit or not for profit is conducted.

Name of the person making this affidavit: _____

Position in the "Business" _____

Name of Entity _____

Address: _____

Phone number: _____

The number of persons or entities in your entity that are required to report under Sec. 21.-28.1 (e): _____

Read the following paragraph and answer one of the options:

Within the 12 month period preceding the date of this bid submission with the City of Providence, or with respect to the contracts that are not in writing within the 12 month period preceding the date of notification that the contract has reached the \$100,000 threshold, have you made campaign contributions within a calendar year to (please list all persons or entities required under Sec. 21.-28.1 (e)).

a. Members of the Providence City Council? Yes No

- If Yes, please complete the following:

Recipient(s) of the Contribution:

Contribution Date(s):

Contribution Amount(s):

b. Candidates for election or reelection to the Providence City Council? Yes No

- If Yes, please complete the following:

Recipient(s) of the Contribution:

Contribution Date(s):

Contribution Amount(s):



**BOARD OF CONTRACT AND SUPPLY
CITY OF PROVIDENCE, RHODE ISLAND**

c. The Mayor of Providence? Yes No

- If Yes, please complete the following:

Recipient(s) of the Contribution:

Contribution Date(s):

Contribution Amount(s):

d. Candidates for election or reelection to the office of Mayor of Providence? Yes No

- If Yes, please complete the following:

Recipient(s) of the Contribution:

Contribution Date(s):

Contribution Amount(s):

Signed under the pains and penalties of perjury.

Position

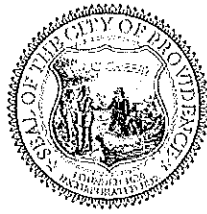

**BOARD OF CONTRACT AND SUPPLY
CITY OF PROVIDENCE, RHODE ISLAND**

WBE/MBE Form Instructions

The City of Providence actively seeks Minority and Women business enterprises to participate in bids to meet the City's procurement needs. Pursuant to the City of Providence Code of Ordinances, Chapter 21, Article II, Sec. 21-52 (Minority and Women's Business Enterprise) and Rhode Island General Laws (as amended), Chapter 37-14, et seq. (Minority Business Enterprise), Minority Business Enterprise (MBE) and Women's Business Enterprise (WBE) participation goals apply to contracts.

The goal for Minority Business Enterprise (MBE) participation is **10%** of the total bid value.
The goal for Women's Business Enterprise (WBE) participation is **10%** of the total bid value.
The goal for combined MBE/WBE participation is **20%** of the total bid value.

Only businesses certified with the State of Rhode Island as minority and/or women business enterprises are counted towards the City's goals. Eligible minority or women-owned businesses are encouraged to seek certification from the State of Rhode Island Minority Business Enterprise Compliance Office at: <https://dedi.ri.gov/divisions-units/minority-business-enterprise-compliance-office>

Note: MBE certification with the State of Rhode Island on the basis of Portuguese heritage is not currently recognized by the City of Providence's MBE program.

Bid Requirements:

1. **All Bidders:** All bidders must complete and submit the *MBE/WBE Participation Affidavit (page 13)* indicating whether or not they are a state-certified MBE/WBE and acknowledging the City's participation goals. Submission of this form is **required with every bid. Your bid will not be accepted without an affidavit.**
2. **Bidders who will be subcontracting:** *In addition to the MBE/WBE Participation Affidavit*, Bidders who will be subcontracting must submit the *Subcontractor Disclosure Form* as part of their bid submission. All subcontractors, regardless of MBE/WBE status, must be listed on this form. Business NAICS codes can be found at <https://www.naics.com/search/>. Awarded bidders are required to submit *Subcontractor Utilization and Payment Reports* with each invoice.
3. **Waiver Requests:**
 - a) If the percentage of the total amount of the bid being awarded to MBE or WBE vendors is less than 20% (Box F on the Subcontractor Disclosure Form) and the prime contractor is not a Rhode Island State-certified MBE or WBE, the Bidder must complete the *MBE/WBE Waiver Request Form (page 14)* and obtain approvals prior to bid submission.
 - b) If the prime contractor company has the capacity to perform the whole project, the City of Providence requires the contractor to complete the *MBE/WBE Waiver Request Form (page 14)* and obtain approvals prior to bid submission.
 - c) If the contractor is a nonprofit organization, they are not required to complete the *MBE/WBE Waiver Request Form*. However, the City of Providence requires the nonprofit organization to provide the *MBE/WBE Participation Affidavit Form* and proof of its nonprofit status.
 - d) If the contractor has researched the RI Certified minority list (<https://dedi.ri.gov/divisions-units/minority-business-enterprise-compliance-office/minority-business-enterprise-mbe>) and the state does not have any companies in the desired trade, the contractor must complete the *MBE/WBE Waiver Request Form (page 14)* and obtain approvals prior to bid submission.
 - e) Waivers will be considered for approval on a case-by-case basis.



**BOARD OF CONTRACT AND SUPPLY
CITY OF PROVIDENCE, RHODE ISLAND**

Verifying MBE/WBE Certification

It is the responsibility of the bidder to confirm that every MBE or WBE named in a proposal and included in a contract is certified by the Rhode Island Minority Business Enterprise Compliance Office. The current MBE/WBE directory is available at the State of RI MBE Office, One Capitol Hill, 2nd Floor, Providence, RI, or online at <http://odeo.ri.gov/offices/mbeco/mbe-wbe.php>. You can also call (401) 574-8670 to verify certification, expiration dates, and services that the MBE/WBE is certified to provide. Note: MBE certification with the State of Rhode Island on the basis of Portuguese heritage is not currently recognized by the City of Providence's MBE program.

Form Instructions:

Access all bid forms from <http://www.providenceri.gov/oeo/> or <http://www.providenceri.gov/purchasing/minority-women-owned-business-mbewbe-procurement-program/>. Download the forms as blank PDFs. Once saved on your computer, fill them out using the Adobe program. The fillable PDFs must be completed in Adobe in order to be saved properly. Google Chrome and similar platforms do not allow for the forms to be saved as filled PDFs. Therefore, please download the blank forms to your computer, then fill them out and save.

Assistance with Form Requirements

Examples of completed forms can be found on the City of Providence website at <http://www.providenceri.gov/oeo/> or <http://www.providenceri.gov/purchasing/minority-women-owned-business-mbewbe-procurement-program/>.

Contract Requirements:

Prime contractors engaging subcontractors must submit the *Subcontractor Utilization and Payment Report* to the City Department's Fiscal Agent with every invoice and request for final payment. A copy of all forms should be sent to the MBE/WBE Outreach Director Office, Grace Diaz at gdiaz@providenceri.gov. This form is not submitted as a part of the initial bid package. For contracts with durations of less than 3 months, this form must be submitted along with the contractor's request for final payment. The form must include all subcontractors utilized on the contract, both MBE/WBE and non- MBE/WBE, the total amount paid to each subcontractor for the given period and to date, A copy of all forms should be sent to the MBE/WBE Outreach Director Office, Grace Diaz at gdiaz@providenceri.gov. During the term of the contract, any unjustified failure to comply with the MBE/WBE participation requirements is a material breach of contract.

Questions?

For more information or for assistance with MBE/WBE Forms, contact the City of Providence MBE/WBE Outreach Director, Grace Diaz, at gdiaz@providenceri.gov or (401) 680-5766.

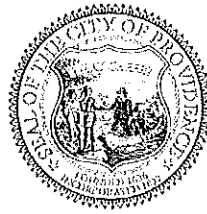

**BOARD OF CONTRACT AND SUPPLY
CITY OF PROVIDENCE, RHODE ISLAND**

MBE/WBE PARTICIPATION AFFIDAVIT

Project /Item Description (as seen on RFP):

Prime Bidder: _____ Contact Email and Phone _____
Company Name, Address and Trade: _____

Which one of the following describes your business' status in terms of Minority and/or Woman-Owned Business Enterprise certification with the State of Rhode Island? MBE WBE Neither MBE nor WBE

By initialing the following sections and signing the bottom of this document in my capacity as the contractor or an authorized representative of contractor, I make this Affidavit:

It is the policy of the City of Providence that minority business enterprises (MBEs) and women business enterprises (WBEs) should have the maximum opportunity to participate in procurements and projects as prime contractors and vendors. Pursuant to Sec. 21-52 of the Providence Code of Ordinances and Chapter 37-14 et seq. of the Rhode Island General Laws (as amended), MBE and WBE participation goals apply to contracts.

The goal for Minority Business Enterprise (MBE) participation is 10% of the total bid value.
The goal for Women's Business Enterprise (WBE) participation is 10% of the total bid value.
The goal for combined MBE/WBE participation is 20% of the total bid value.

I acknowledge the City of Providence's goals of supporting MBE/WBE certified businesses. Initial _____

If awarded the contract, I understand that my company must submit to the Minority and Women's Business Coordinator at the City of Providence (MBE/WBE Office), copies of all executed agreements with the subcontractor(s) being utilized to achieve the participation goals and other requirements of the RI General Laws. **I understand that these documents must be submitted prior to the issuance of a notice to proceed.** Initial _____

I understand that, if awarded the contract, my firm must submit to the MBE/WBE Office canceled checks and reports required by the MBE/WBE Office on a quarterly basis verifying payments to the subcontractors(s) utilized on the contract. Initial _____

If I am awarded this contract and find that I am unable to utilize the subcontractor(s) identified in my Statement of Intent, I understand that I must substitute another certified MBE and WBE firm(s) to meet the participation goals. **I understand that I may not make a substitution until I have obtained the written approval of the MBE/WBE Office.**

Initial _____

If awarded this contract, I understand that authorized representatives of the City of Providence may examine the books, records and files of my firm from time to time, to the extent that such material is relevant to a determination of whether my firm is complying with the City's MBE/WBE participation requirements.

Initial _____

I do solemnly declare and affirm under the penalty of perjury that the contents of the foregoing Affidavit are true and correct to the best of my knowledge, information, and belief.

Signature of Bidder

Printed Name

Company Name

Date

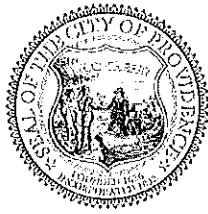

**BOARD OF CONTRACT AND SUPPLY
CITY OF PROVIDENCE, RHODE ISLAND**

SUBCONTRACTOR DISCLOSURE FORM

Fill out this form only if you **WILL SUBCONTRACT** with other parties. If you will not subcontract any portion of the proposed bid, do not fill out this form.

Prime Bidder: _____ Primary NAICS _____

Code: _____

Item Description (as seen on RFP): _____

Please list all Subcontractors below. Include the total dollar value that you propose to share with each subcontractor and the dollar amount to be subcontracted. Please check off MBE and WBE where applicable. The directory of all state-certified MBE/WBE firms is located at www.mbe.ri.gov. Business NAICS codes can be found at <https://www.naics.com/search/>

Proposed Subcontractor	MBE	WBE	Primary NAICS Code	Date of Mobilization	\$ Value of Subcontract
					\$
					\$
					\$
					\$
					\$
					\$
A. MBE SUBCONTRACTED AMOUNT:					\$
B. WBE SUBCONTRACTED AMOUNT:					\$
C. NON-MBE WBE SUBCONTRACTED AMOUNT:					\$
D. DOLLAR AMOUNT OF WORK DONE BY THE PRIME CONTRACTOR:					\$
E. TOTAL AMOUNT OF BID (SUM OF A, B, C, & D):					\$
F. PERCENTAGE OF BID SUBCONTRACTED TO MBEs AND WBEs. (Divide the sum of A and B by E and multiply result by 100).					%

Please read and initial the following statement acknowledging you understand. If the percentage of the total amount of the bid being awarded to MBE or WBE vendors is less than 20% (Box (F)) and the prime contractor is NOT a Rhode Island State-certified MBE or WBE, you must fill out the **MBE/WBE WAIVER REQUEST FORM** for consideration by City of Providence MBE/WBE Outreach Director. Initial _____ Required

Signature of Bidder

Printed Name



**BOARD OF CONTRACT AND SUPPLY
CITY OF PROVIDENCE, RHODE ISLAND**

MBE/WBE Waiver Request Form

Fill out this form only if you did not meet the 20% MBE/WBE participation goal.
State-certified MBE or WBE Prime Bidders are **NOT REQUIRED** to fill out this form.

Submit this form to the City of Providence MBE/WBE Outreach Director, Grace Diaz, at gdiaz@providenceri.gov, for review prior to bid submission. This waiver applies only to the current bid which you are submitting to the City of Providence and does not apply to other bids your company may submit in the future. **In case a waiver is needed, City Department Directors should not recommend a bidder for an award if this form is not included, absent or is not signed by the city of Providence MBE/WBE director.**

Prime Bidder: _____ Contact Email and Phone _____
Company Name, Address: _____ Trade _____
Project /Item Description (as seen on RFP):

To receive a waiver, you must list the certified MBE and/or WBE companies you contacted, the name of the primary individual with whom you interacted, and the reason the MBE/WBE company could not participate on this project.

MBE/WBE Company Name	Individual's Name	Company Name	Why did you choose not to work with this company?

I acknowledge the City of Providence's goal of a combined MBE/WBE participation is 20% of the total bid value. I am requesting a waiver of _____ % MBE/WBE (20% minus the value of **Box F** on the Subcontractor Disclosure Form). If an opportunity is identified to subcontract any task associated with the fulfillment of this contract, a good faith effort will be made to select MBE/WBE certified businesses as partners.

Signature of Prime Contractor /
or Duly Authorized Representative

Printed Name

Date Signed

Signature of City of Providence
MBE/WBE Outreach Director /
or Duly Authorized Representative

Printed Name of City of Providence
MBE/WBE Outreach Director

Date Signed



**BOARD OF CONTRACT AND SUPPLY
CITY OF PROVIDENCE, RHODE ISLAND**

BID PACKAGE SPECIFICATIONS

Background Information

The Department of Public Works of the City of Providence, RI is seeking for qualified bidders to provide Inlet Stones (Curbing) necessary to replace inlets damaged by vehicles, school buses, plows, among others, that drive over them. Additionally, inlet stones are used for new draining systems.

Scope of Work

See below.

Selection/Evaluation Criteria

See below.

BACK SURFACE SHALL HAVE NO PROJECTIONS FOR A DISTANCE OF 3" DOWN FROM THE TOP UNLESS OTHERWISE SAWN

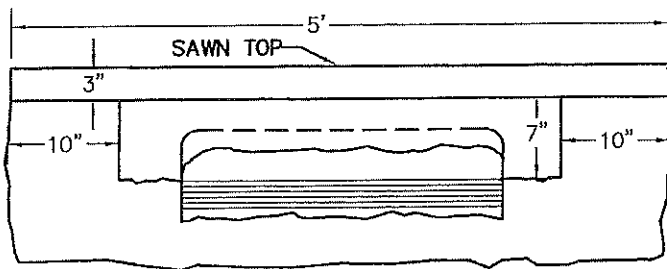

REAR VIEW
N.T.S.

QUARRY FACED WITH NO PORTIONS MORE THAN 1" ABOVE OR MORE THAN 1" BELOW A GENERAL PLANE, UNLESS OTHERWISE SAWN

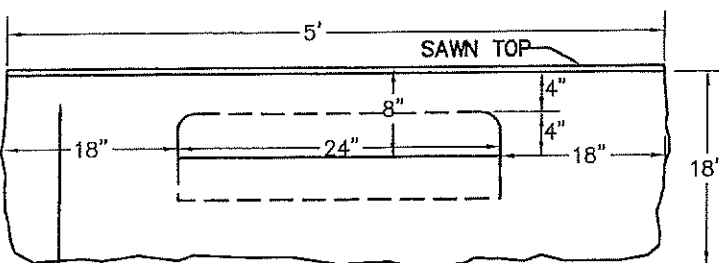

FRONT VIEW
N.T.S.

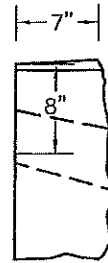

END OF ALL STONES SHALL BE SQUARE AND SO FINISHED THAT WHEN STONES ARE SET NO SPACE MORE THAN 1/4" SHALL SHOW IN THE JOINT FOR THE FULL WIDTH OF THE TOP OR DOWN THE FACE FOR 9", UNLESS OTHERWISE SAWN

LOWER HALF OF ENDS MAY BE QUARRY FACED WITH NO PROJECTIONS BEYOND DEPRESSED PORTION AND NO DEPRESSION MORE THAN 1" DEEP

FRONT FACE SHALL BE AT RIGHT ANGLES TO THE PLANE OF THE TOP AND SHALL BE SMOOTH QUARRY SPLIT, UNLESS OTHERWISE SAWN

FRONT FACE SHALL HAVE NO PROJECTION GREATER THAN 3/4" OR DEPRESSION GREATER THAN 1/2" FOR A DISTANCE DOWN FROM THE TOP OF 9", UNLESS OTHERWISE SAWN

GRANITE INLET STONE
24" OPENING



TOP SURFACE OF APRON OR REGULAR INLET STONE SHALL BE SAWN TO APPROXIMATELY TRUE PLANES TOP SURFACE SHALL HAVE NO PROJECTION OR DEPRESSION GRATER THAN 1/8".

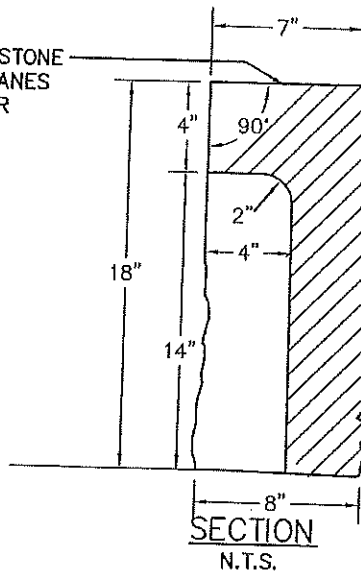

END OF ALL STONES SHALL BE SQUARE AND SO FINISHED THAT WHEN STONES ARE SET NO SPACE MORE THAN 1/4" SHALL SHOW IN THE JOINT FOR THE FULL WIDTH OF THE TOP OR DOWN THE FACE FOR 9"

QUARRY FACED WITH NO PORTIONS MORE THAN 1" ABOVE OR MORE THAN 1" BELOW A GENERAL PLANE, UNLESS OTHERWISE SAWN

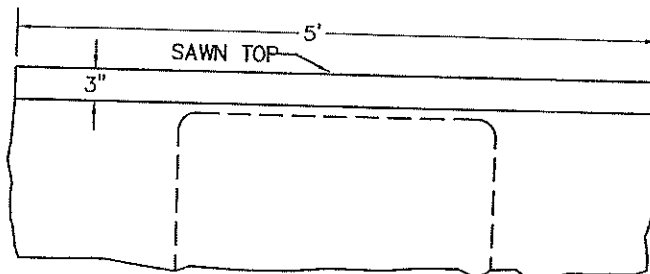

FRONT FACE SHALL BE AT RIGHT ANGLES TO THE PLANE OF THE TOP AND SHALL BE SMOOTH QUARRYSPLIT UNLESS OTHERWISE SAWN

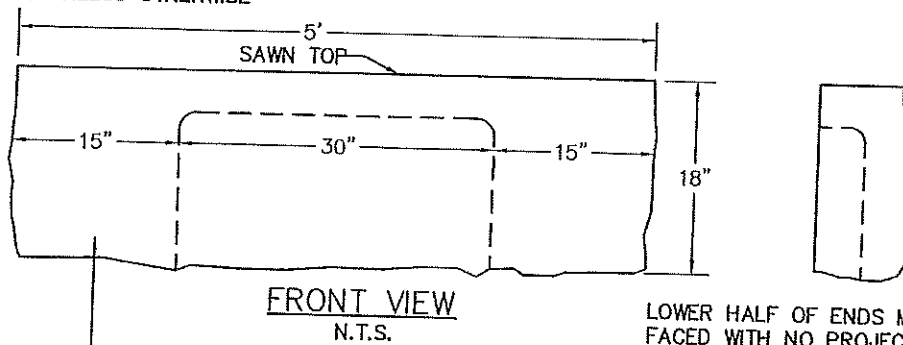

LOWER HALF OF ENDS MAY BE QUARRY FACED WITH NO PROJECTIONS BEYOND DEPRESSED PORTION AND NO DEPRESSION MORE THAN 1" DEEP

FRONT FACE SHALL HAVE NO PROJECTION GREATER THAN 3/4" OR DEPRESSION GREATER THAN 1/2" FOR A DISTANCE DOWN FROM THE TOP OF 9" UNLESS OTHERWISE SAWN

GRANITE APRON STONE
30" OPENING



BACK SURFACE SHALL HAVE NO PROJECTIONS FOR A DISTANCE OF 3" DOWN FROM THE TOP UNLESS OTHERWISE SAWN

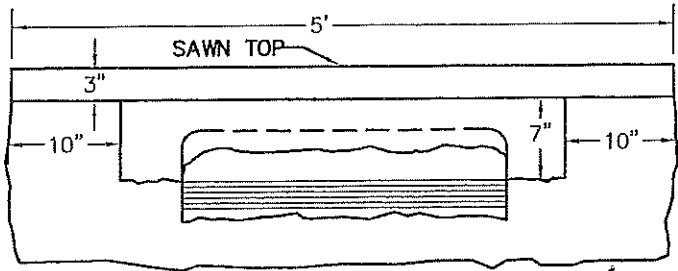

REAR VIEW
N.T.S.

QUARRY FACED WITH NO PORTIONS MORE THAN 1" ABOVE OR MORE THAN 1" BELOW A GENERAL PLANE, UNLESS OTHERWISE SAWN

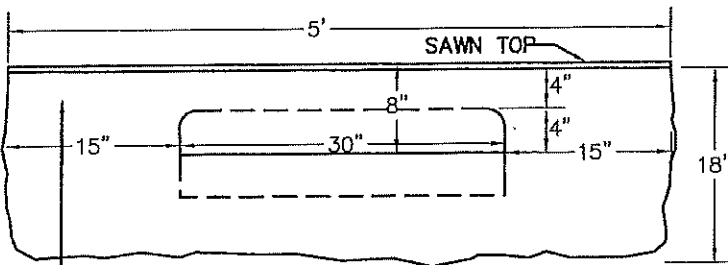

FRONT VIEW
N.T.S.

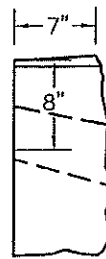

END OF ALL STONES SHALL BE SQUARE AND SO FINISHED THAT WHEN STONES ARE SET NO SPACE MORE THAN 1/4" SHALL SHOW IN THE JOINT FOR THE FULL WIDTH OF THE TOP OR DOWN THE FACE FOR 9," UNLESS OTHERWISE SAWN

LOWER HALF OF ENDS MAY BE QUARRY FACED WITH NO PROJECTIONS BEYOND DEPRESSED PORTION AND NO DEPRESSION MORE THAN 1" DEEP

FRONT FACE SHALL BE AT RIGHT ANGLES TO THE PLANE OF THE TOP AND SHALL BE SMOOTH QUARRY SPLIT, UNLESS OTHERWISE SAWN

FRONT FACE SHALL HAVE NO PROJECTION GREATER THAN 3/4" OR DEPRESSION GREATER THAN 1/2" FOR A DISTANCE DOWN FROM THE TOP OF 9", UNLESS OTHERWISE SAWN

GRANITE INLET STONE
30" OPENING



BACK SURFACE SHALL HAVE NO PROJECTIONS FOR A DISTANCE OF 3" DOWN FROM THE TOP UNLESS OTHERWISE SAWN

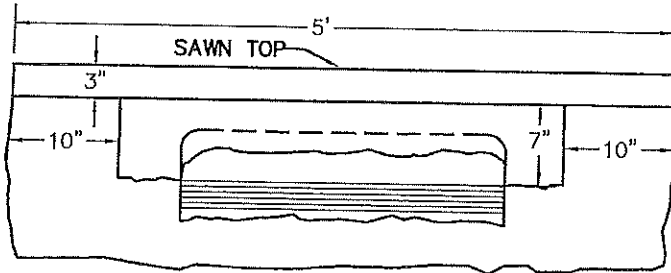

REAR VIEW
N.T.S.

QUARRY FACED WITH NO PORTIONS MORE THAN 1" ABOVE OR MORE THAN 1" BELOW A GENERAL PLANE, UNLESS OTHERWISE SAWN

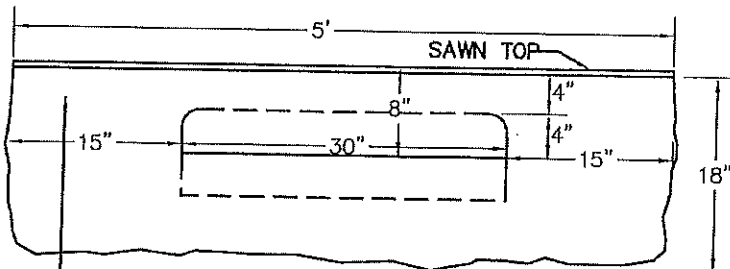

FRONT VIEW
N.T.S.

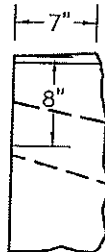

END OF ALL STONES SHALL BE SQUARE AND SO FINISHED THAT WHEN STONES ARE SET NO SPACE MORE THAN 1/4" SHALL SHOW IN THE JOINT FOR THE FULL WIDTH OF THE TOP OR DOWN THE FACE FOR 9", UNLESS OTHERWISE SAWN

LOWER HALF OF ENDS MAY BE QUARRY FACED WITH NO PROJECTIONS BEYOND DEPRESSED PORTION AND NO DEPRESSION MORE THAN 1" DEEP

FRONT FACE SHALL BE AT RIGHT ANGLES TO THE PLANE OF THE TOP AND SHALL BE SMOOTH QUARRY SPLIT, UNLESS OTHERWISE SAWN

FRONT FACE SHALL HAVE NO PROJECTION GREATER THAN 3/4" OR DEPRESSION GREATER THAN 1/2" FOR A DISTANCE DOWN FROM THE TOP OF 9", UNLESS OTHERWISE SAWN

GRANITE INLET STONE
30" OPENING



TOP SURFACE OF APRON OR REGULAR INLET STONE SHALL BE SAWN TO APPROXIMATELY TRUE PLANES TOP SURFACE SHALL HAVE NO PROJECTION OR DEPRESSION GRATER THAN 1/8".

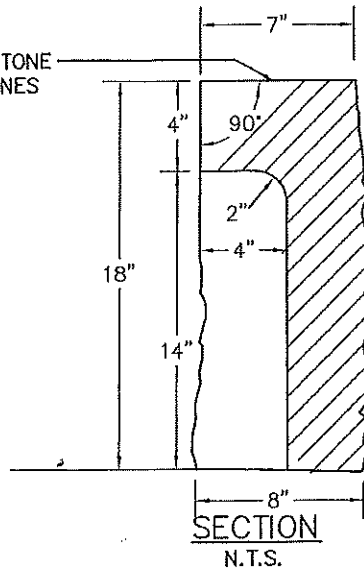

END OF ALL STONES SHALL BE SQUARE AND SO FINISHED THAT WHEN STONES ARE SET NO SPACE MORE THAN 1/4" SHALL SHOW IN THE JOINT FOR THE FULL WIDTH OF THE TOP OR DOWN THE FACE FOR 9"

QUARRY FACED WITH NO PORTIONS MORE THAN 1" ABOVE OR MORE THAN 1" BELOW A GENERAL PLANE, UNLESS OTHERWISE SAWN

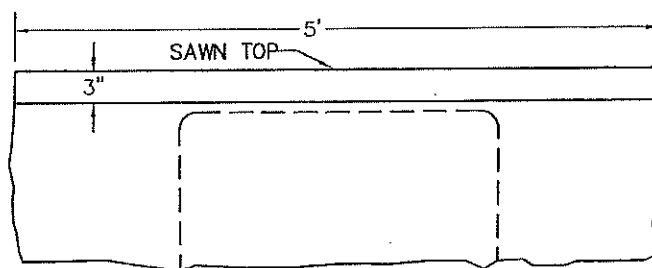

FRONT FACE SHALL BE AT RIGHT ANGLES TO THE PLANE OF THE TOP AND SHALL BE SMOOTH QUARRYSPLIT UNLESS OTHERWISE SAWN

REAR VIEW
N.T.S.

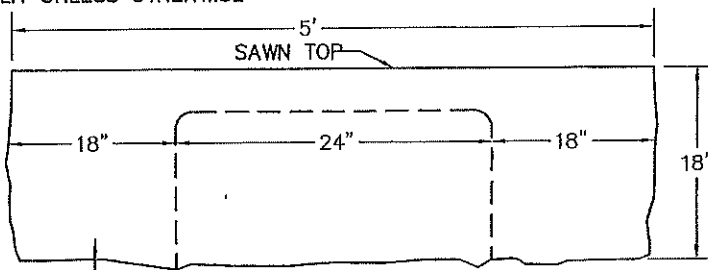

FRONT VIEW
N.T.S.

LOWER HALF OF ENDS MAY BE QUARRY FACED WITH NO PROJECTIONS BEYOND DEPRESSED PORTION AND NO DEPRESSION MORE THAN 1" DEEP

FRONT FACE SHALL HAVE NO PROJECTION GREATER THAN 3/4" OR DEPRESSION GREATER THAN 1/2" FOR A DISTANCE DOWN FROM THE TOP OF 9" UNLESS OTHERWISE SAWN

GRANITE APRON STONE
24" OPENING



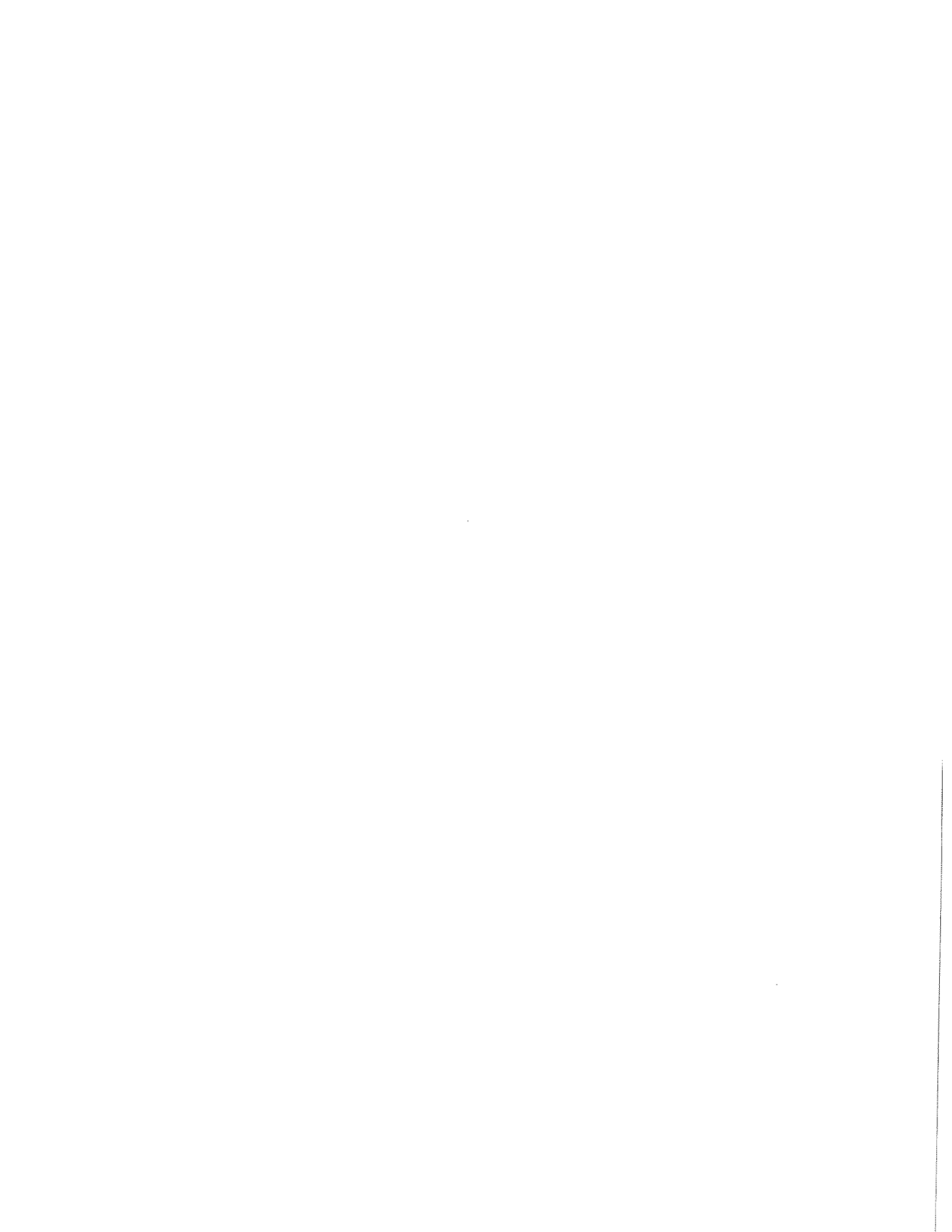



**BOARD OF CONTRACT AND SUPPLY
CITY OF PROVIDENCE, RHODE ISLAND**

SUPPLEMENTAL INFORMATION

If the issuing department for this RFP determines that your firm's bid is best suited to accommodate their need, you will be asked to provide proof of the following prior to formalizing an award.

An inability to provide the outlined items at the request of the department may lead to the disqualification of your bid.

*This information is **NOT** requested to be provided in your initial bid that you will submit to the City Clerk's office by the "date to be opened" noted on page 1. This list only serves as a list of items that your firm should be ready to provide on request.*

All bids submitted to the City Clerk become public record. Failure to follow instructions could result in information considered private being posted to the city's Open Meetings Portal and made available as a public record.

You must be able to provide:

- Business Tax ID will be requested after an award is approved by the Board of Contract and Supply.
- Proof of Insurance.
- Certificate of Good Standing with the Rhode Island Secretary of State.
- **USE THESE BULLETS TO OUTLINE ITEMS YOU WILL NEED VENDORS TO PRODUCE ON REQUEST IF YOU SEEK TO AWARD THIS BID TO THEM.**



**BOARD OF CONTRACT AND SUPPLY
CITY OF PROVIDENCE, RHODE ISLAND**

CITY OF PROVIDENCE STANDARD TERMS & CONDITIONS

1. The terms "you" and "your" contained herein refer to the person or entity that is a party to the agreement with the City of Providence ("the City") and to such person's or entity's employees, officers, and agents.
2. The Request For Proposals ("RFP") and these Standard Terms and Conditions together constitute the entire agreement of the parties ("the Agreement") with regard to any and all matters. By your submission of a bid proposal or response to the City's RFP, you accept these Standard Terms & Conditions and agree that they supersede any conflicting provisions provided by bid or in any terms and conditions contained or linked within a bid and/or response. Changes in the terms and conditions of the Agreement, or the scope of work thereunder, may only be made by a writing signed by the parties.
3. You are an independent contractor and in no way does this Agreement render you an employee or agent of the City or entitle you to fringe benefits, workers' compensation, pension obligations, retirement or any other employment benefits. The City shall not deduct federal or state income taxes, social security or Medicare withholdings, or any other taxes required to be deducted by an employer, and this is your responsibility to yourself and your employees and agents.
4. You shall not assign your rights and obligations under this Agreement without the prior written consent of the City. Any assignment without prior written consent of the City shall be voidable at the election of the City. The City retains the right to refuse any and all assignments in the City's sole and absolute discretion.
5. Invoices submitted to the City shall be payable sixty (60) days from the time of receipt by the City. Invoices shall include support documentation necessary to evidence completion of the work being invoiced. The City may request any other reasonable documentation in support of an invoice. The time for payment shall not commence, and invoices shall not be processed for payment, until you provide reasonably sufficient support documentation. In no circumstances shall the City be obligated to pay or shall you be entitled to receive interest on any overdue invoice or payment. In no circumstances shall the City be obligated to pay any costs associated with your collection of an outstanding invoice.
6. For contracts involving construction, alteration, and/or repair work, the provisions of applicable state labor law concerning payment of prevailing wage rates (R.I. Gen. Laws §§ 37-13-1 et seq., as amended) and the City's First Source Ordinance (Providence Code of Ordinances §§ 21-91 et seq., as amended) apply.
7. With regard to any issues, claims, or controversies that may arise under this Agreement, the City shall not be required to submit to dispute resolution or mandatory/binding arbitration. Nothing prevents the parties from mutually agreeing to settle any disputes using mediation or non-binding arbitration.
8. To the fullest extent permitted by law, you shall indemnify, defend, and hold harmless the City, its employees, officers, agents, and assigns from and against any and all claims, damages, losses, allegations, demands, actions, causes of action, suits, obligations, fines, penalties, judgments, liabilities, costs and expenses, including but not limited to attorneys' fees, of any nature whatsoever arising out of, in connection with, or resulting from the performance of the work provided in the Agreement.
9. You shall maintain throughout the term of this Agreement the insurance coverage that is required by the RFP or, if none is required in the RFP, insurance coverage that is considered in your industry to be commercially reasonable, and you agree to name the City as an additional insured on your general liability policy and on any umbrella policy you carry.
10. The City shall not subject itself to any contractual limitations on liability. The City shall have the time permitted within the applicable statute of limitations, and no less, to bring or assert any and all causes of action, suits, claims or demands the City may have arising out of, in connection with, or resulting from the performance of the work provided in the Agreement, and in no event does the City agree to limit your liability to the price of the Agreement or any other monetary limit.
11. The City may terminate this Agreement upon five (5) days' written notice to you if you fail to observe any of the terms and conditions of this Agreement, or if the City believes your ability to perform the



**BOARD OF CONTRACT AND SUPPLY
CITY OF PROVIDENCE, RHODE ISLAND**

terms and conditions of this Agreement has been materially impaired in any way, including but in no way limited to loss of insurance coverage, lapsing of a surety bond, if required, declaration of bankruptcy, or appointment of a receiver. In the event of termination by the City, you shall be entitled to just and equitable compensation for any satisfactory work completed and expenses incurred up to the date of termination.

12. Written notice hereunder shall be deemed to have been duly served if delivered in person to the individual or member of the firm or entity or to an officer of the entity for whom it was intended, or if delivered at or sent by registered or certified mail to the last business address known by the party providing notice.
13. In no event shall the Agreement automatically renew or be extended without a writing signed by the parties.
14. You agree that products produced or resulting from the performance of the Agreement are the sole property of the City and may not be used by you without the express written permission of the City.
15. For any Agreement involving the sharing or exchange of data involving potentially confidential and/or personal information, you shall comply with any and all state and/or federal laws or regulations applicable to confidential and/or personal information you receive from the City, including but not limited to the Rhode Island Identity Theft Protection Act, R.I. Gen. Laws § 11-49.3-1, during the term of the Agreement. You shall implement and maintain appropriate physical, technical, and administrative security measures for the protection of, and to prevent access to, use, or disclosure of, confidential and/or personal information. In the event of a breach of such information, you shall notify the City of such breach immediately, but in no event later than twenty-four (24) hours after discovery of such breach.
16. The Agreement is governed by the laws of the State of Rhode Island. You expressly submit yourself to and agree that any and all actions arising out of, in connection with, or resulting from the performance of the Agreement or relationship between the parties shall occur solely in the venue and jurisdiction of the State of Rhode Island or the federal court located in Rhode Island.
17. The failure of the City to require performance of any provision shall not affect the City's right to require performance at any time thereafter, nor shall a waiver of any breach or default of this Agreement constitute a waiver of any subsequent breach or default or a waiver of the provision itself.
18. If any term or provision of this Agreement, or the application thereof to any person or circumstance shall, in any extent, be invalid or unenforceable, the remainder of this Agreement shall not be affected thereby, and each term and provision shall be valid and enforceable to the fullest extent permitted by law.

